

# DIAMANT

**BP4** French rocket, launched 1975  
Scale 1 : 144

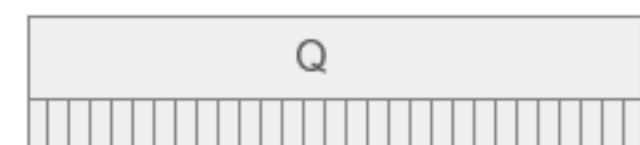

Glue X on bottom plate.

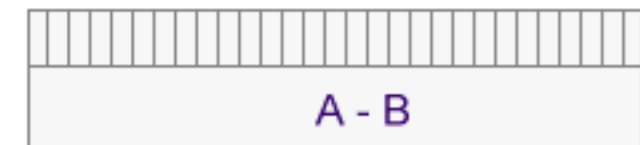
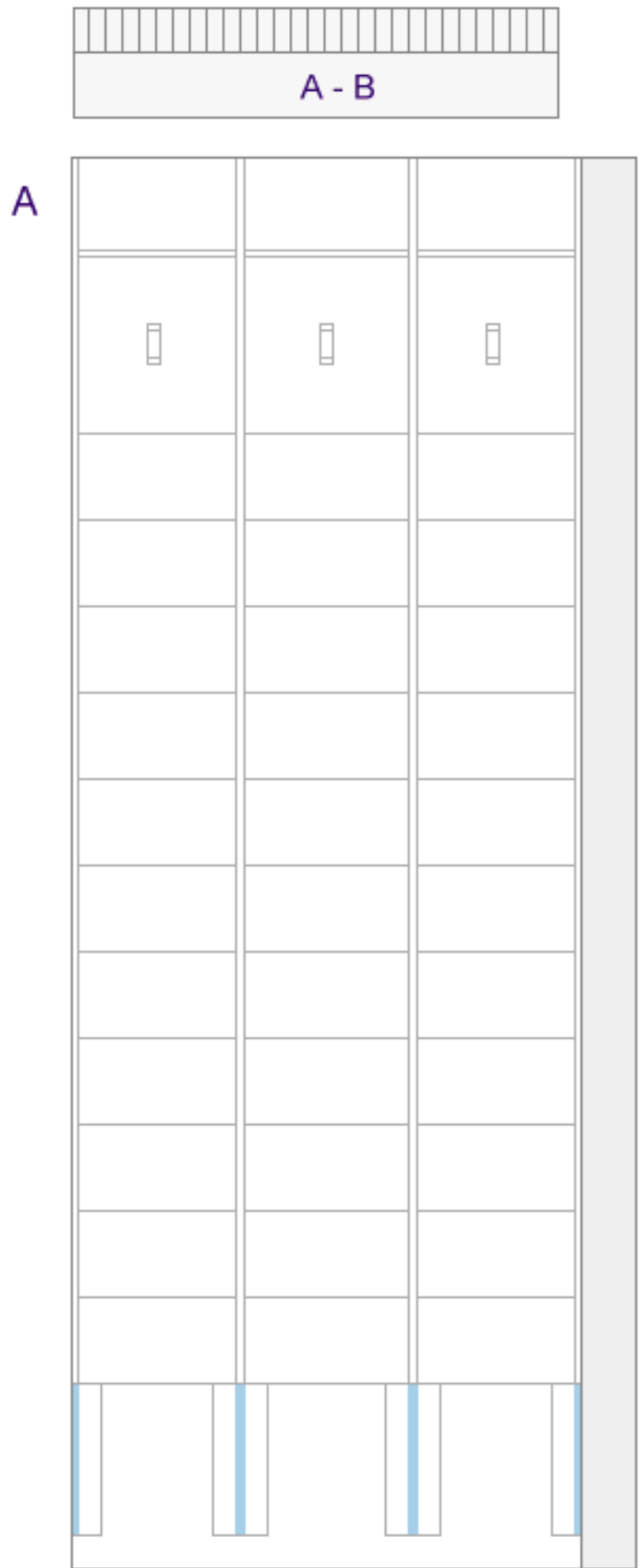
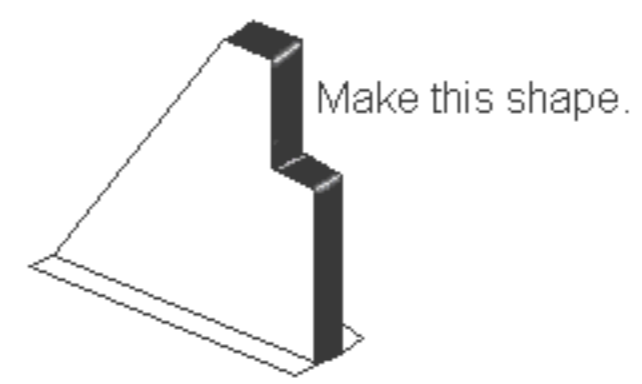
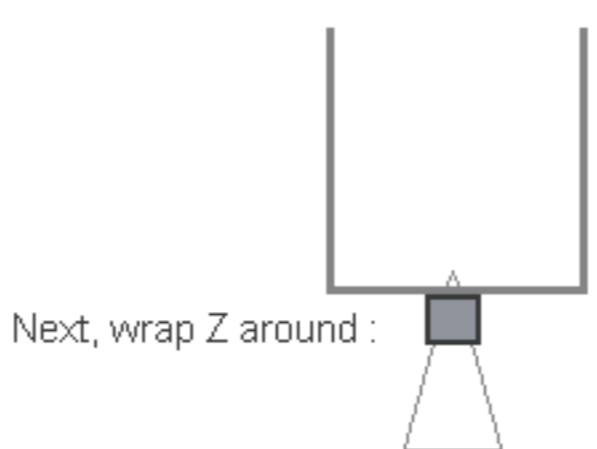
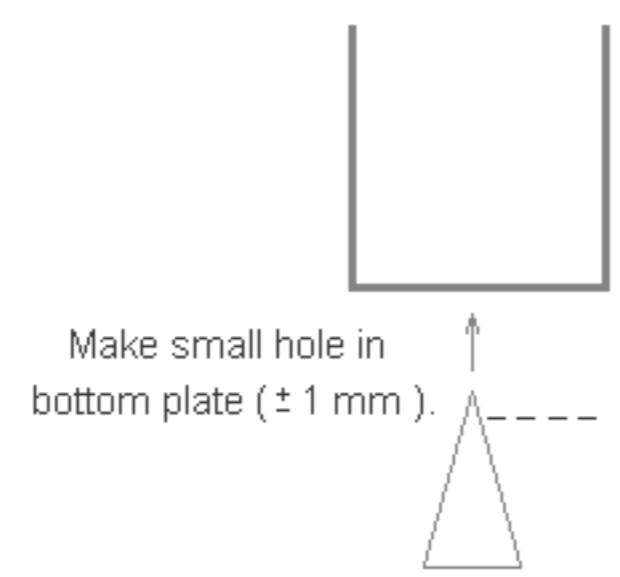
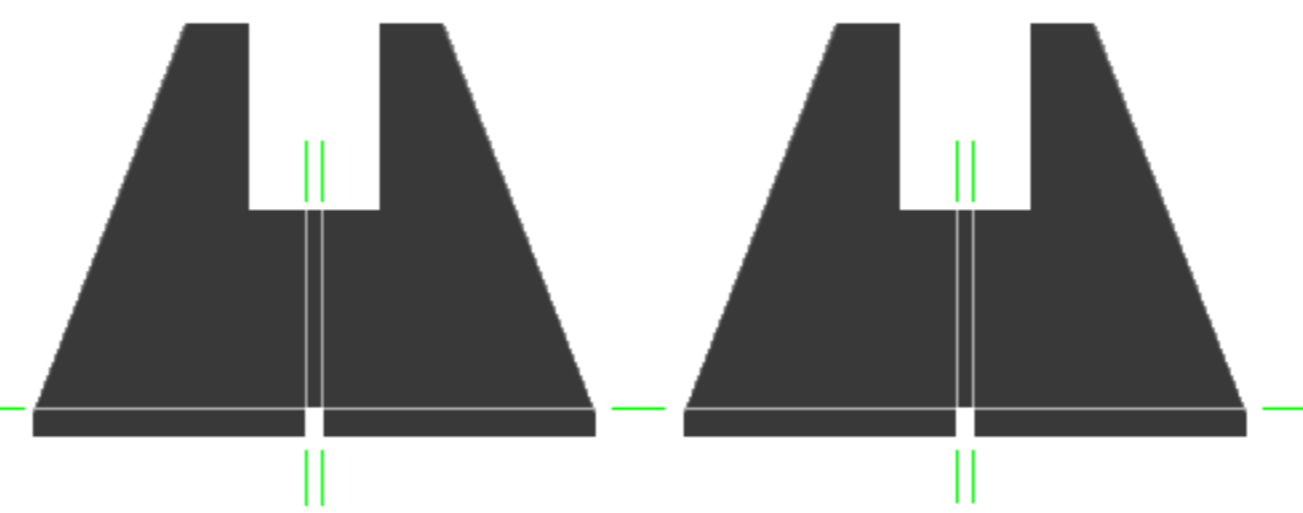
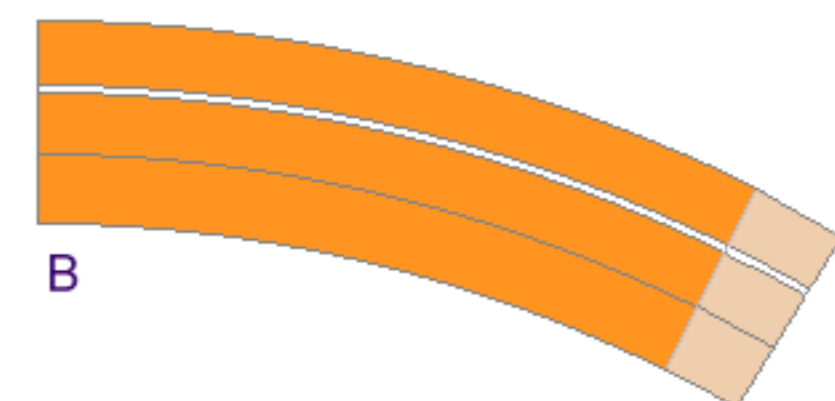
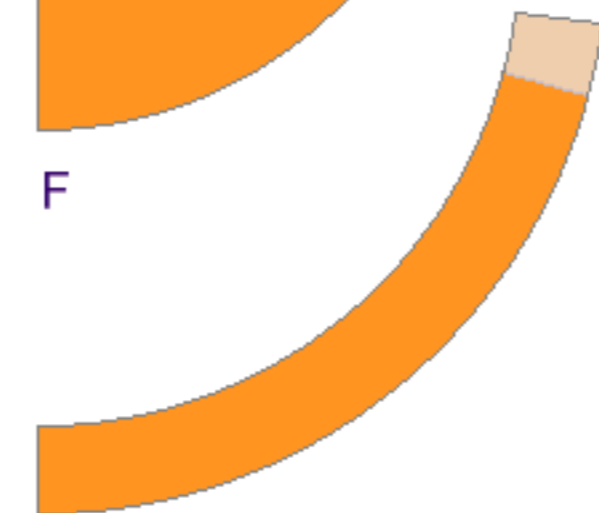
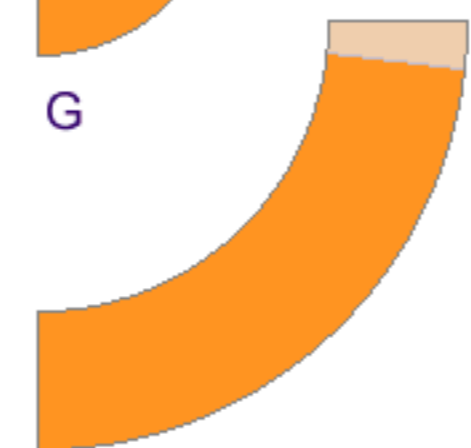
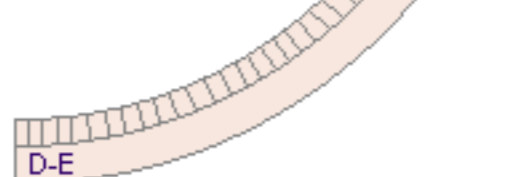
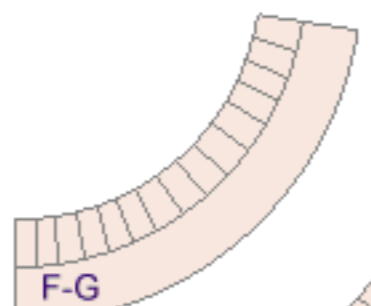
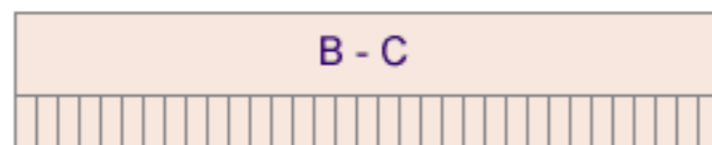
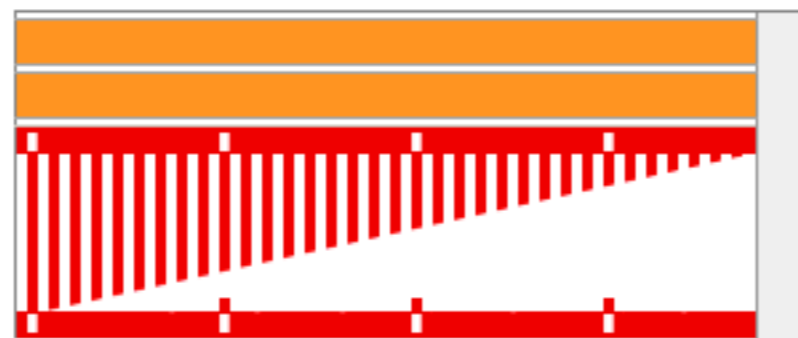
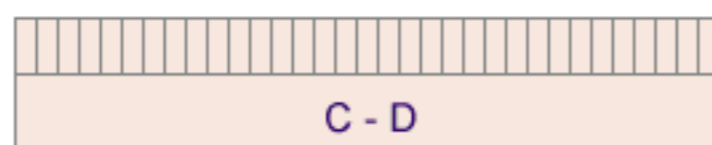

Glue this part on extra thick cardstock.

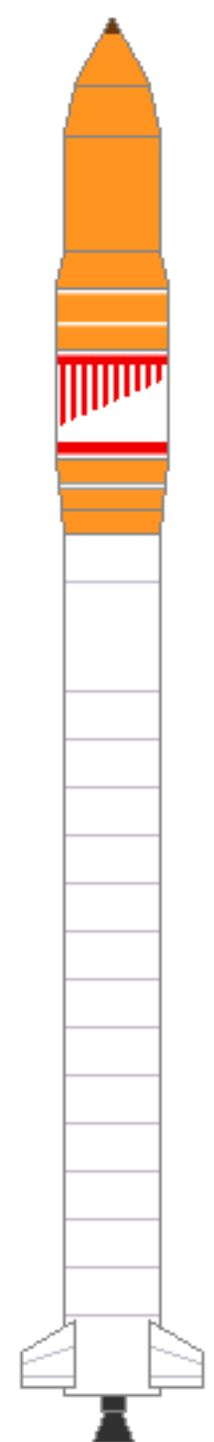
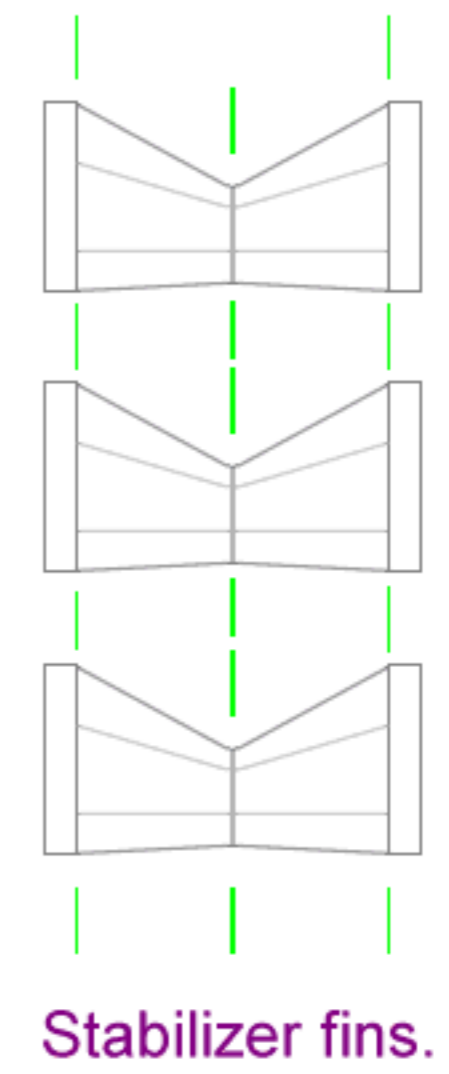
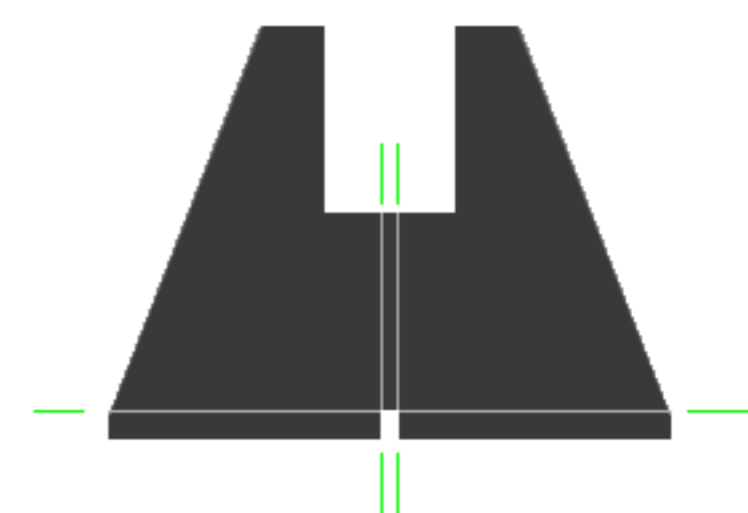

# Instructions for DIAMANT BP 4

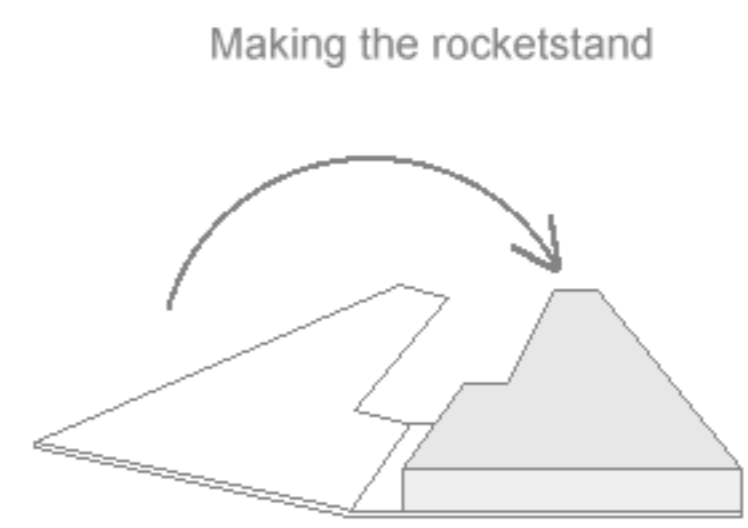
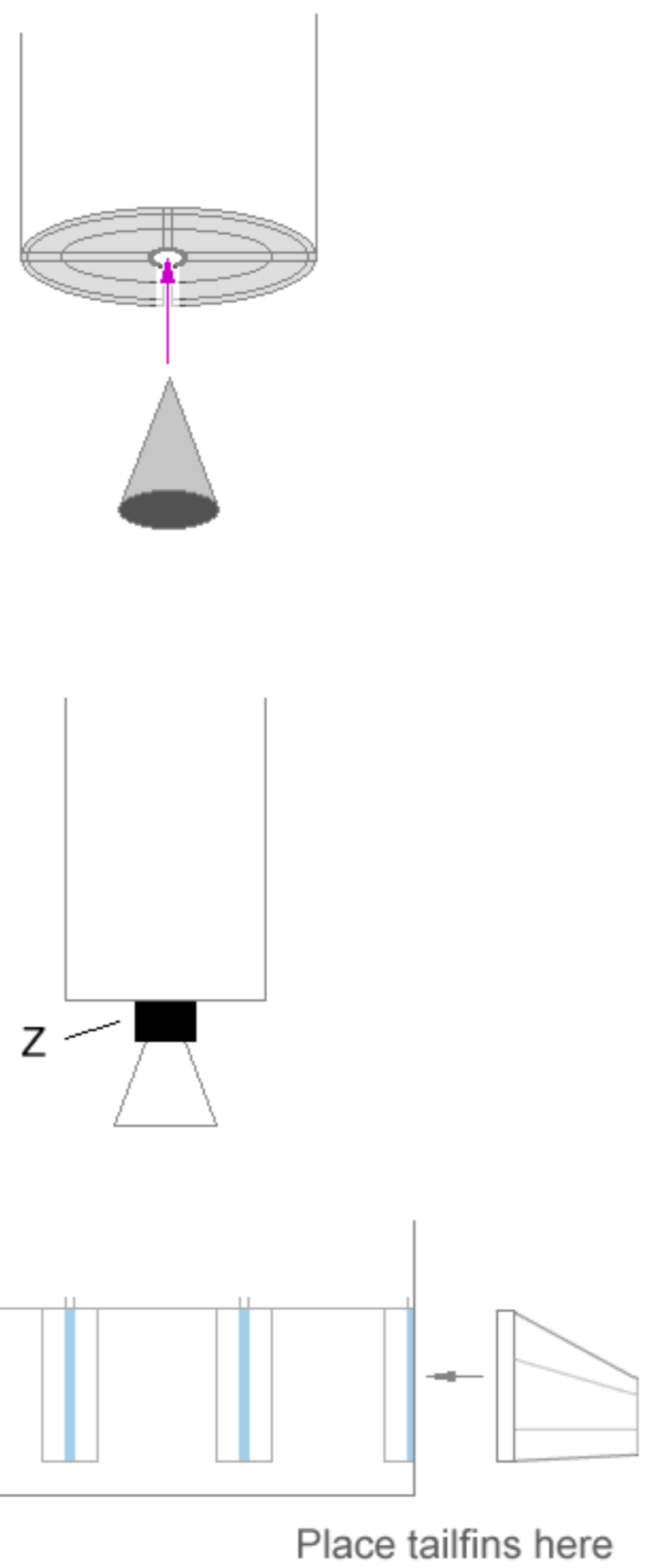
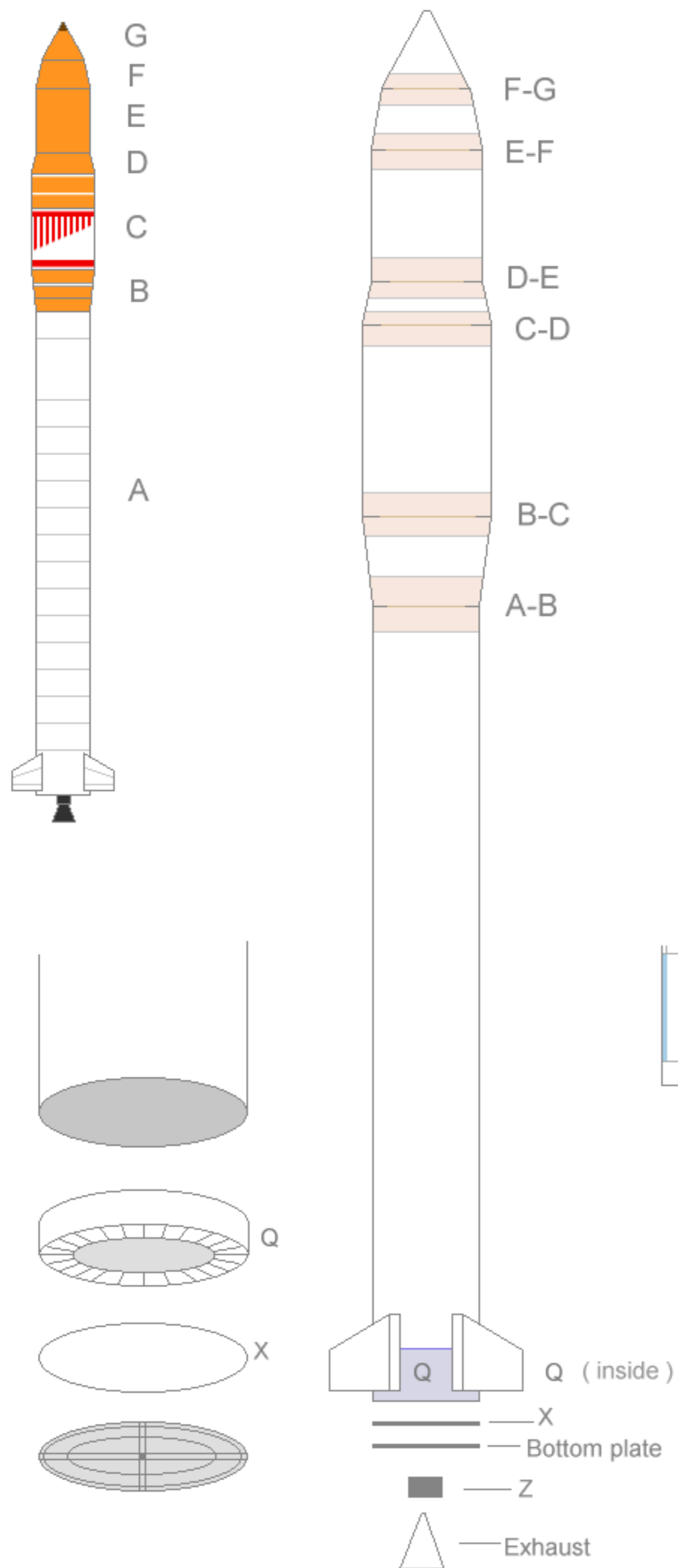

Glue a thick piece of cardboard in between the two black halves.

