

# Lunar Prospector Spacecraft 1/25 Scale Model      Parts Sheet 1

Visit the Lunar Prospector Web Site <http://lunarprospector.arc.nasa.gov>  
 Assembly Instructions are on the web.

## SCIENCE INSTRUMENT BOOMS

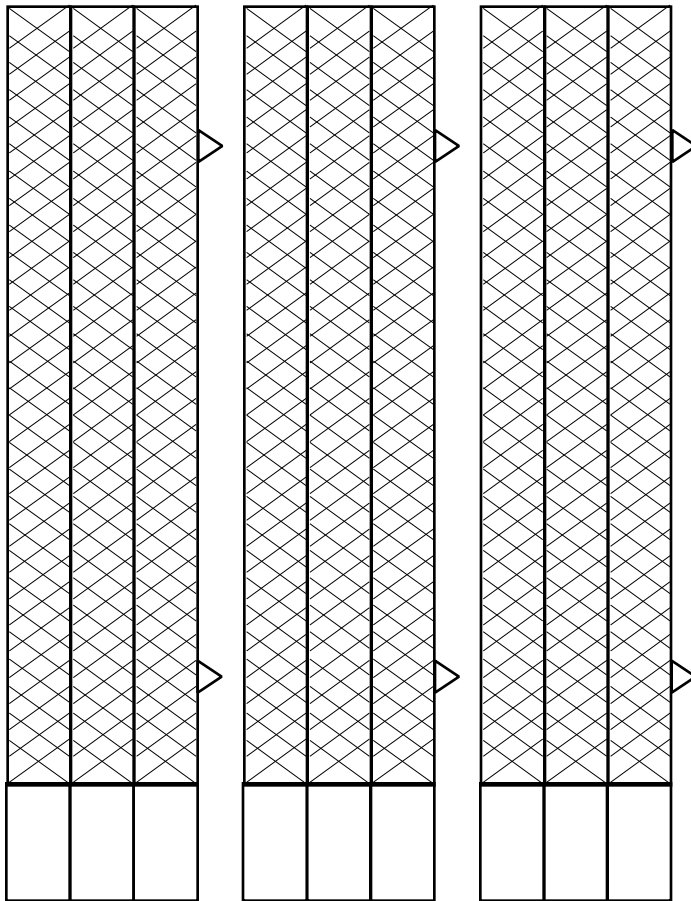

## ALPHA PROTON SECTROMETER AND NEUTRON SPECTROMETER

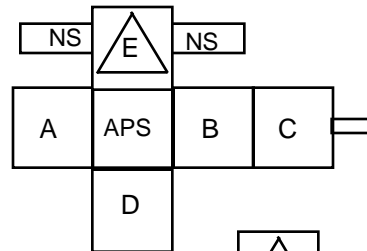

## SCIENCE INSTRUMENTS

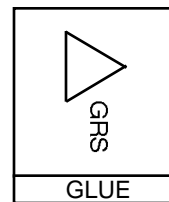
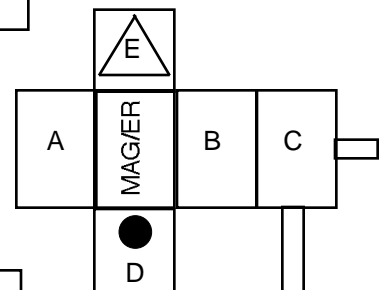

## GAMMA RAY SPECTROMETER

MAGNETOMETER / ELECTRON RELECTOMETER



## SPACECRAFT BUS

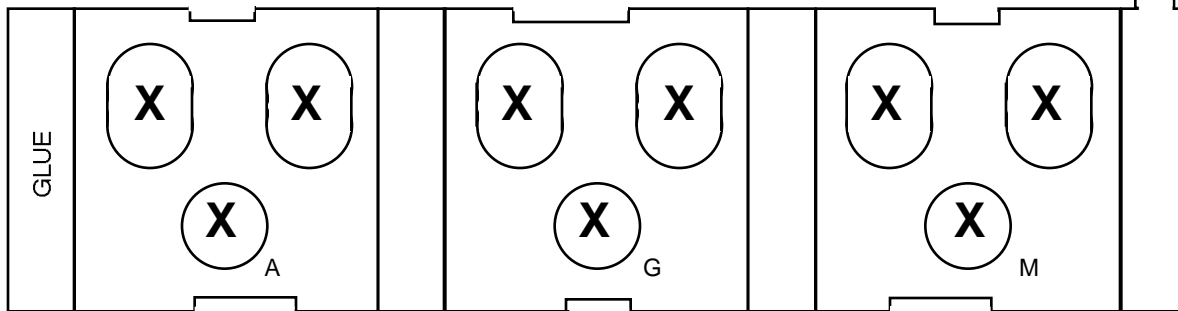

Cut out and remove circles and ovals marked "X"

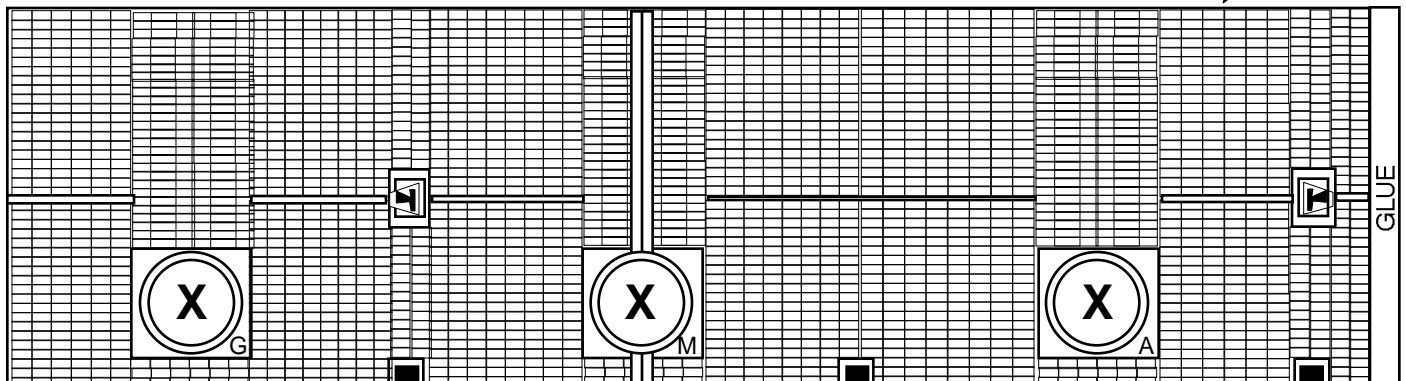

# Lunar Prospector Spacecraft 1/25 Scale Model      Parts Sheet 2

Visit the Lunar Prospector Web Site <http://lunarprospector.arc.nasa.gov>  
Assembly Instructions are on the web.

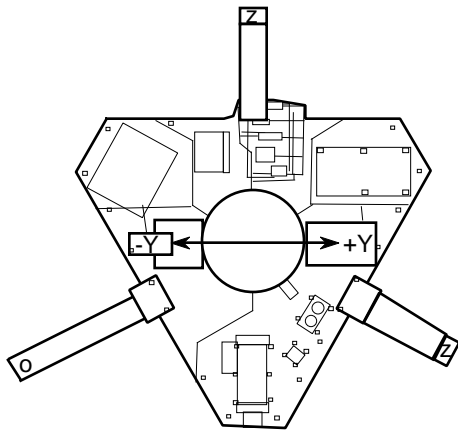

SPACECRAFT BUS TOP

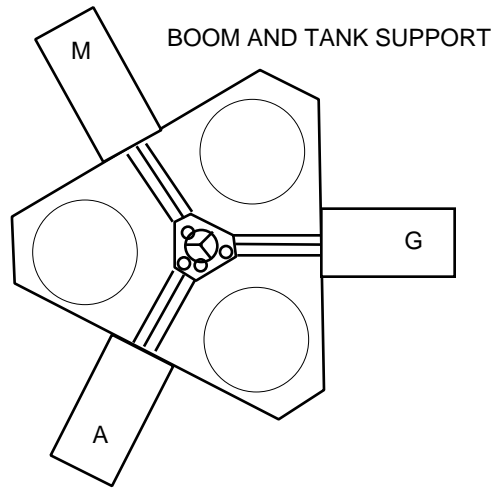

BOOM AND TANK SUPPORT

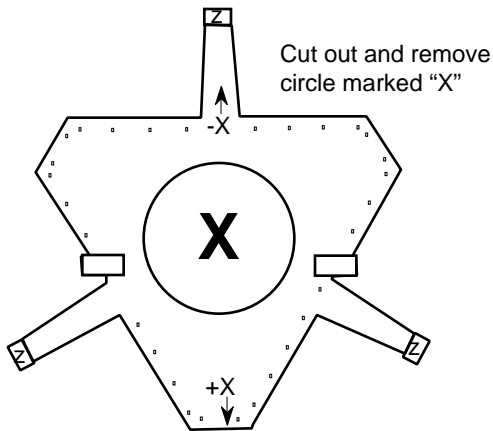

Cut out and remove circle marked "X"

SPACECRAFT BUS BOTTOM

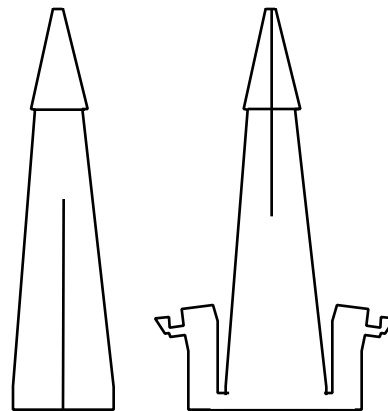

COMMUNICATIONS ANTENNA HALVES  
(With +Z Thrusters)

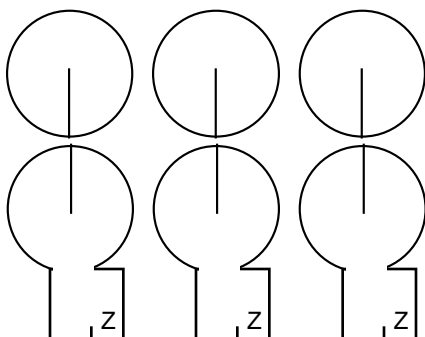

PROPELLANT TANK HALVES



$-Z$  THRUSTERS