

Parts Sheet A

PRINT ON CARD STOCK

34-METER BEAM WAVEGUIDE DEEP SPACE STATION 1/250 SCALE MODEL

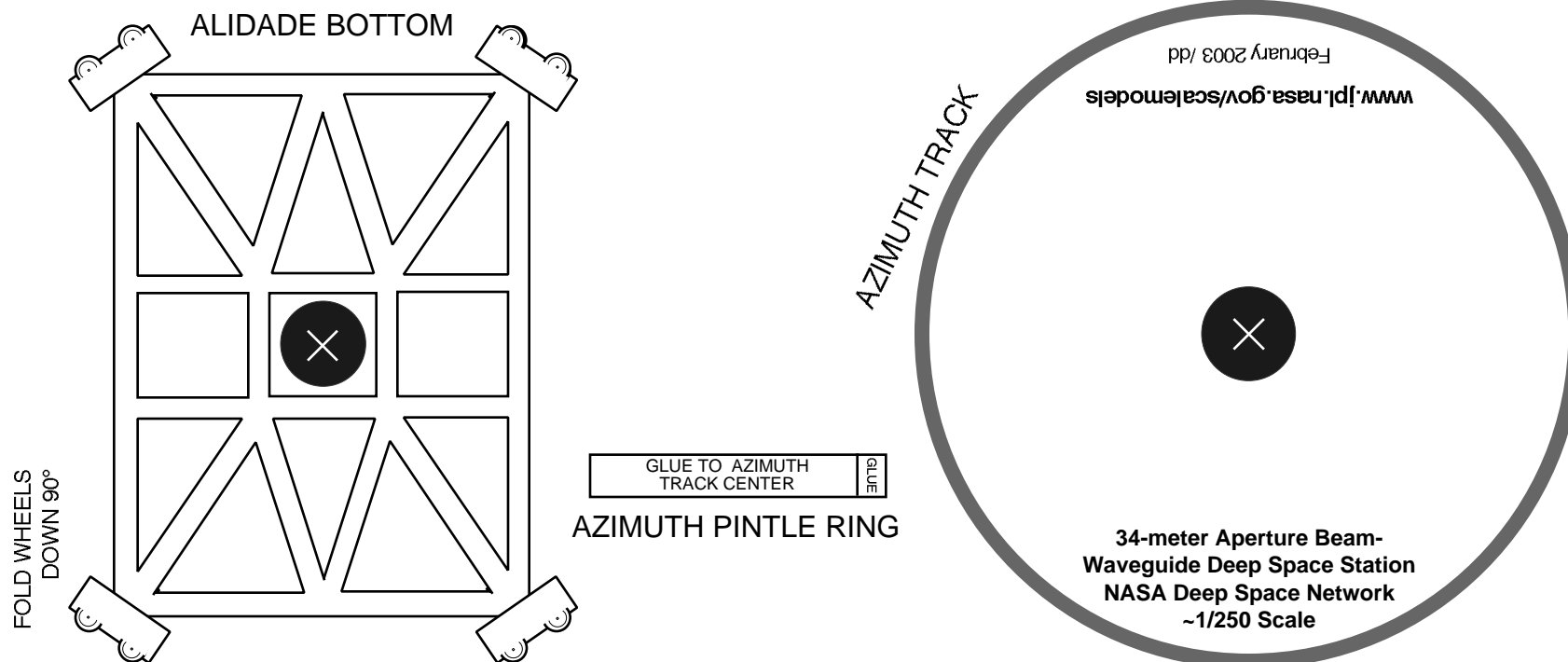

<http://www.jpl.nasa.gov/scalemodels>

PRINT
CALIBRATION

1 CM

Parts
Sheet B

PRINT ON
CARD STOCK

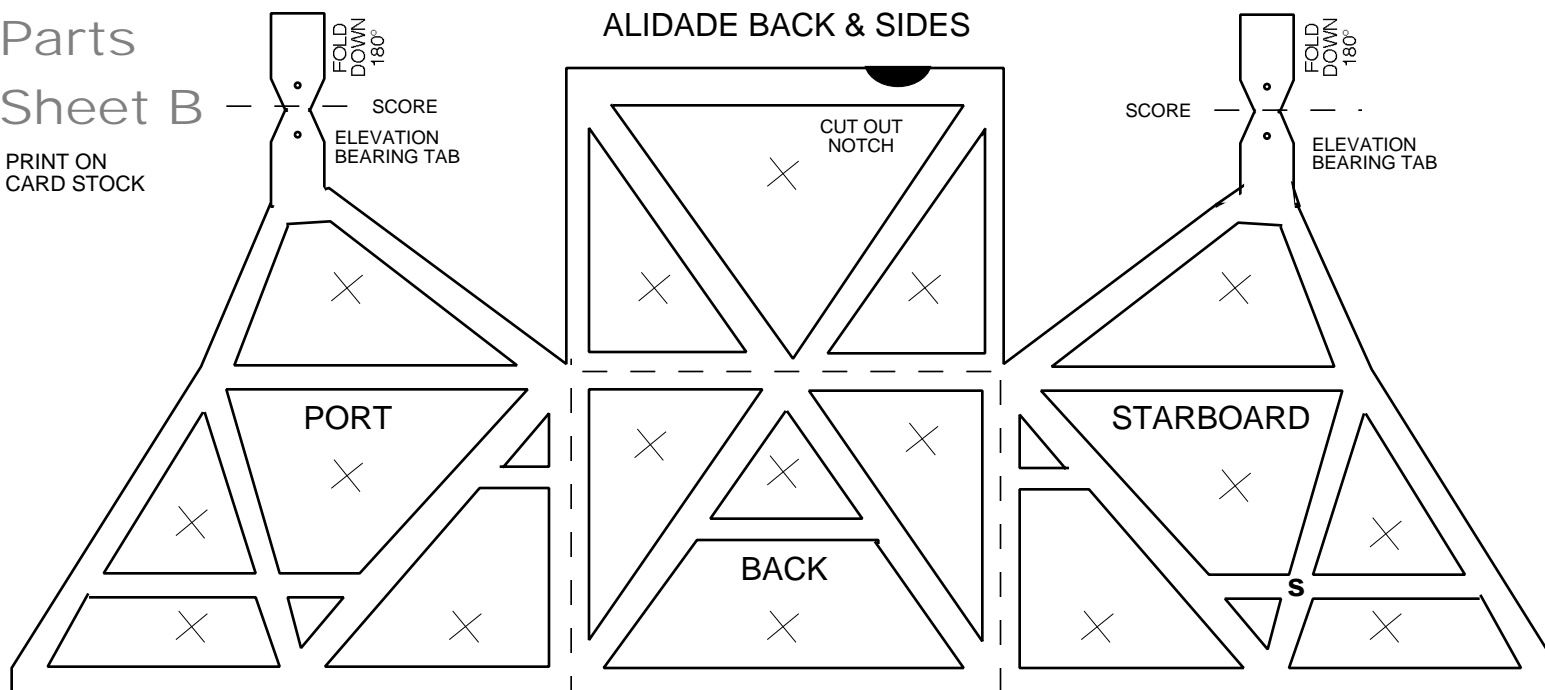

34-METER
BEAM
WAVEGUIDE
DEEP SPACE
STATION
1/250 SCALE
MODEL

PRINT
CALIBRATION



ALIDADE FRONT

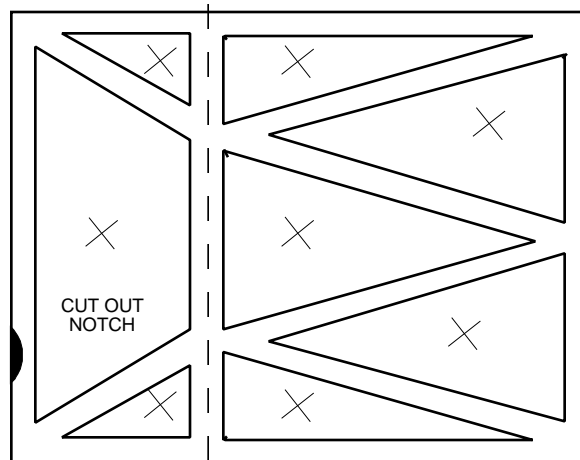

SCORE
BOTTOM

www.jpl.nasa.gov/scalemodels

Parts Sheet C

PRINT ON CARD STOCK

34-METER BEAM

WAVEGUIDE DEEP SPACE

STATION 1/250 SCALE MODEL

<http://www.jpl.nasa.gov/scalemodels>

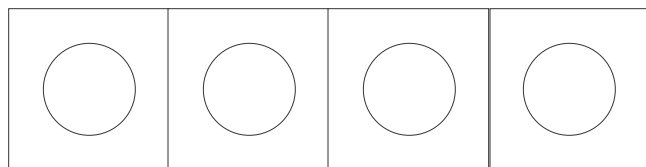
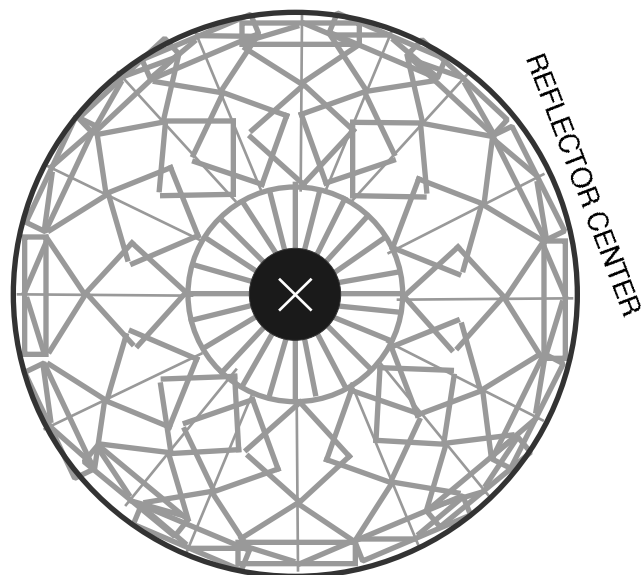

CUT OUT SQUARES FOR MAKING WAVEGUIDE CAPS

UPPER PERISCOPE

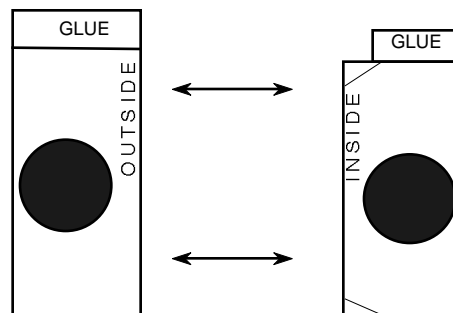

UPPER VERTICAL WAVEGUIDE #1



MAIN VERTICAL WAVEGUIDE #2

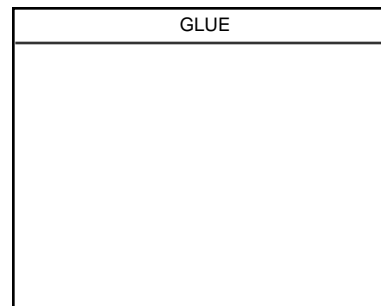

LOWER PERISCOPE

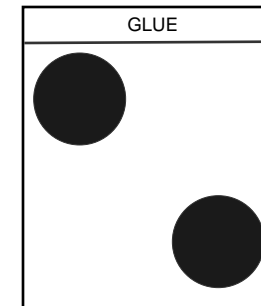

LOWER VERTICAL WAVEGUIDE #3

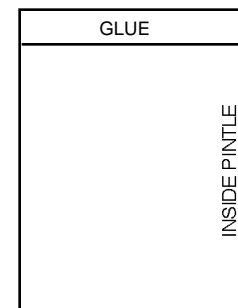

1 CM
PRINT CALIBRATION

Parts Sheet D

PRINT ON CARD STOCK

**34-METER BEAM WAVEGUIDE DEEP SPACE STATION
1/250 SCALE MODEL**

ELEVATION BEARING
(2 PIECES)

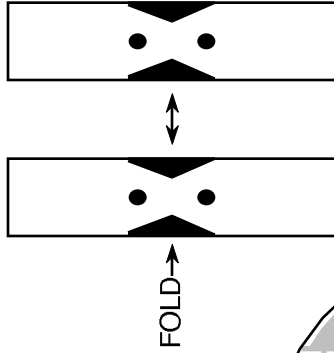

COUNTERWEIGHT
(3 PIECES)

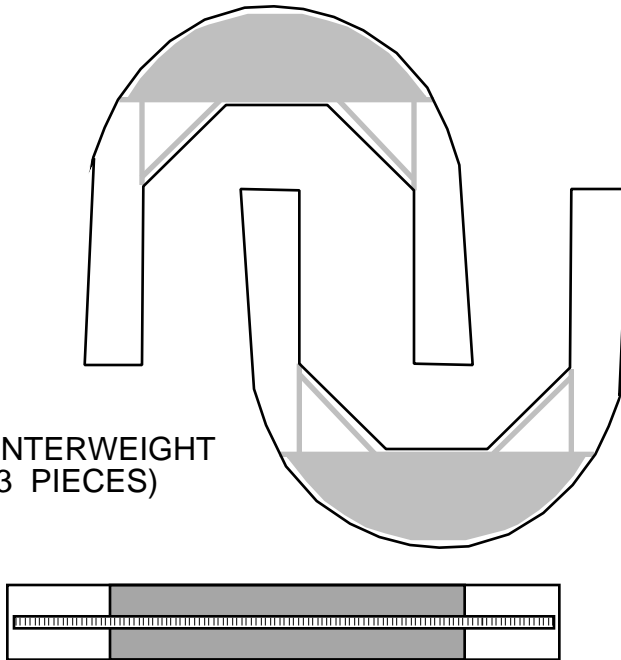

QUADRAPOD
(4 PIECES)

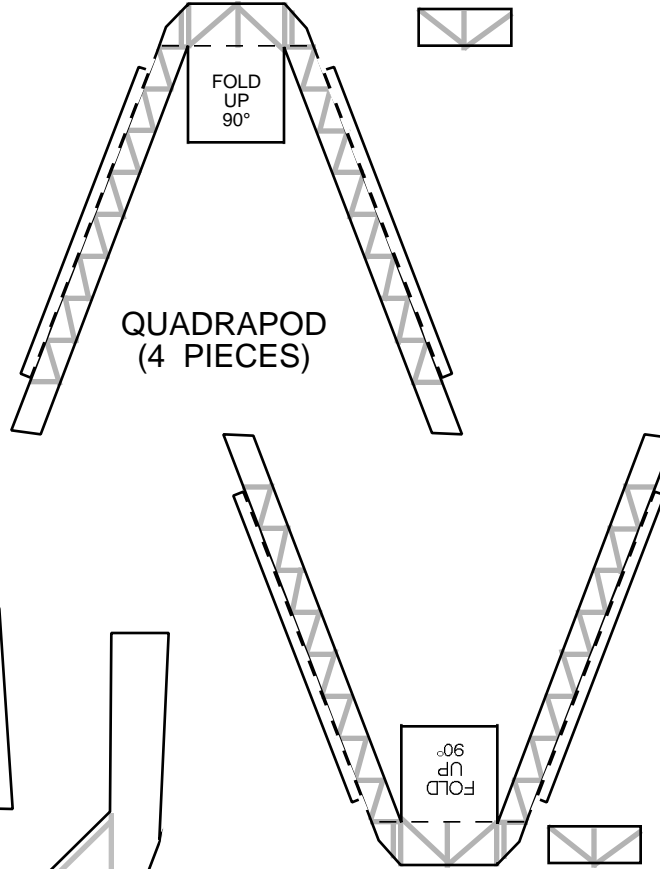

1 CM
PRINT
CALIBRATION

<http://www.jpl.nasa.gov/scalemodels>

Parts Sheet E

PRINT ON LIGHTWEIGHT PAPER
(REGULAR COPIER PAPER)

**34-METER BEAM WAVEGUIDE DEEP SPACE STATION
1/250 SCALE MODEL**

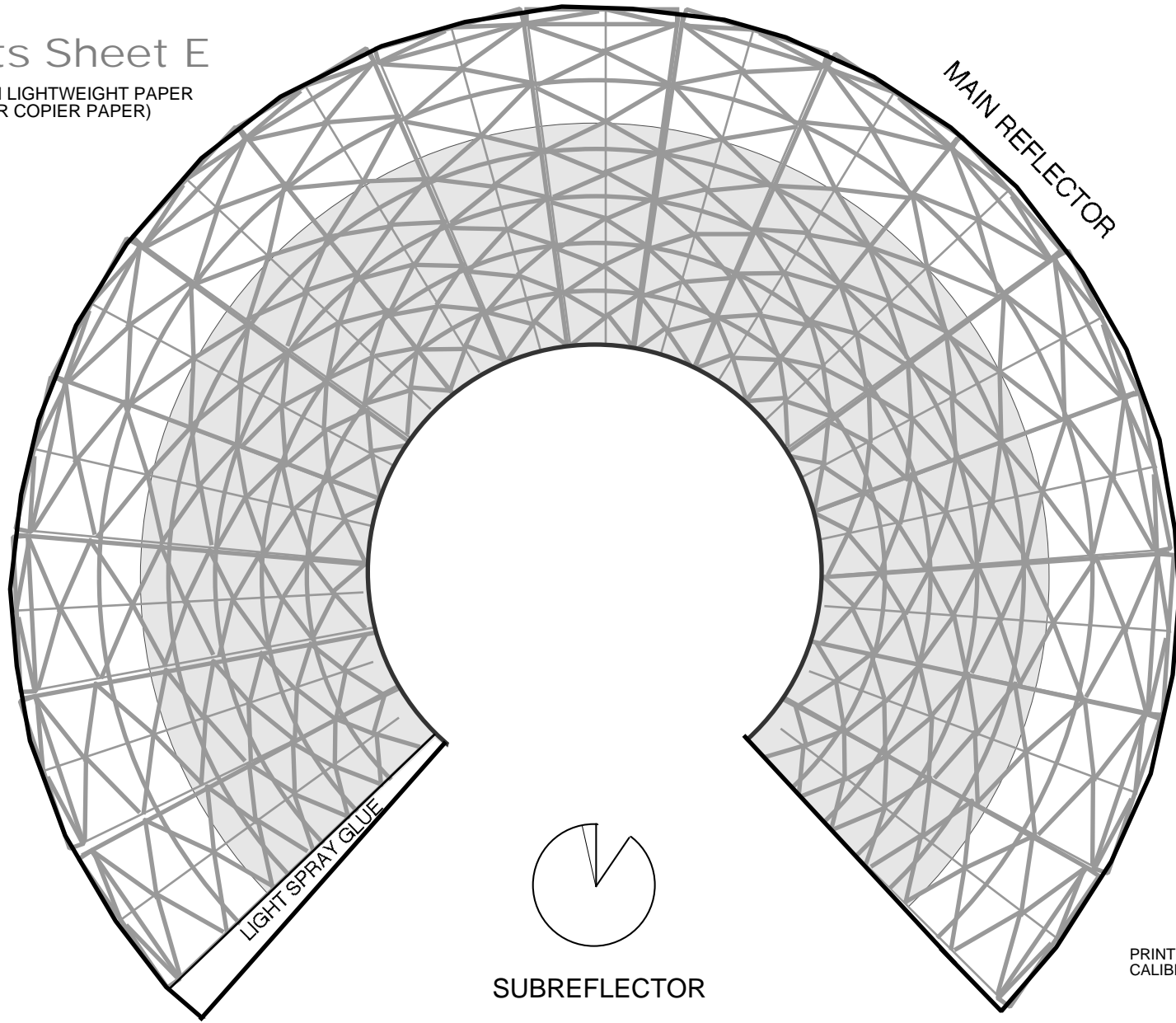

MAIN REFLECTOR

LIGHT SPRAY GLUE

SUBREFLECTOR

PRINT CALIBRATION 1 CM

<http://www.jpl.nasa.gov/scalemodels>